

Shelly 1PM Gen3



Device identification

- Device name: **Shelly 1PM Gen3**
- Device model: **S3SW-001P16EU**
- Device SSID: **Shelly1PMG3-XXXXXXXXXXXX**
- BLE Model ID: **0x1019**

Short description

Shelly 1PM Gen3 is a small form factor smart switch with power measurement, which allows remote control of electric appliances through a mobile phone, tablet, PC, or home automation system. It can work standalone in a local Wi-Fi network or it can also be operated through cloud home automation services. The device also has improved processor and increased memory compared to its predecessor.

Shelly 1PM Gen3 can be accessed, controlled and monitored remotely from any place where the User has internet connectivity, as long as the device is connected to a Wi-Fi router and the Internet.

It can be retrofitted into standard electrical wall boxes, behind power sockets and light switches or other places with limited space.

Shelly 1PM Gen3 has embedded Web Interface which can be used to monitor and control the device, as well as adjust its settings.

Main features

- **Wi-Fi Connectivity:** The device can connect to your home Wi-Fi network, allowing you to remotely monitor humidity and temperature data through a smartphone app or other compatible devices.
- **Integration with Smart Home Platforms:** You can integrate the Shelly i4 Gen3 with popular smart home platforms, including Google, Alexa, and Samsung SmartThings. This enables voice control and automation capabilities through these platforms.
- **Smart Switch with Power Measurement:** Acts as a smart switch with the added capability of measuring power consumption, allowing you to monitor the energy usage of connected appliances.
- **Compact Design:** Designed as a small form factor switch, making it suitable for retrofitting into standard electrical wall boxes, behind power sockets, light switches, or other confined spaces.
- **Remote Control:** Enables remote control of electric appliances via a mobile phone, tablet, PC, or home automation system.
- **Local and Cloud Control:** Can function independently in a local Wi-Fi network and can also be operated through cloud home automation services.
- **Improved Processor and Memory:** Upgraded with an improved processor and increased memory for enhanced performance.
- **Remote Access:** Allows remote access, control, and monitoring from any location with internet connectivity, provided the device is connected to a Wi-Fi router and the internet.
- **Embedded Web Interface:** Features an embedded web interface for monitoring, control, and adjustment of settings.
- **Wireless Connectivity:** The device supports Wi-Fi (802.11 b/g/n) and Bluetooth 4.2 protocols with specified indoor and outdoor range capabilities.
- **BLE Gateway:** Bridge between your Shelly BLU devices and the wider Shelly ecosystem. It receives Bluetooth signals and sends them to the cloud or locally to another non-bluetooth device.
- **Wi-Fi Range extender for IoT devices:** A Wi-Fi extender is employed to expand the reach of your Wi-Fi network by receiving your current Wi-Fi signal, enhancing its strength, and then transmitting the enhanced signal over a wider area.
- **Scripting:** <https://shelly-api-docs.shelly.cloud/gen2/Scripts/ShellyScriptLanguageFeatures/>
- **Wide range of integrations:** The device can be integrated with 3rd party home systems, documented HTTP API, MQTT(s), Web Hooks over HTTP and HTTPS, UDP
- **KNX:** Supports [KNXnet/IP](#) communication

- **Schedules:** Allows scheduling of complex operations to be executed in predefined time window. Users can specify time windows based on date, time of day, weekdays, hours, minutes and seconds.
- **Virtual Components:** <https://shelly-api-docs.shelly.cloud/gen2/DynamicComponents/Virtual/>

Use cases

- **Appliance Control:** Use it to remotely control and automate the operation of various electric appliances such as lights, fans, or other devices.
- **Power Monitoring:** Monitor the power consumption of connected appliances in real-time. This is useful for understanding energy usage patterns and promoting energy efficiency.
- **Home Automation:** Integrate the Shelly 1PM Gen3 into your home automation system to create custom scenes and schedules for your devices.
- **Energy Efficiency:** Leverage the power measurement feature to identify energy-hungry appliances and make informed decisions to improve overall energy efficiency in your home.
- **Remote Monitoring:** Keep an eye on your devices even when you're away from home. The remote access feature allows you to monitor and control connected appliances from anywhere with internet connectivity.

Main applications

- Residential
- MDU (Multi Dwelling Units - apartments, condominiums, hotels, etc.)
- Light commercial (small office buildings, small retail/restaurant/gas station, etc.)
- Government/municipal
- University/college

Integrations

Amazon Alexa supported capabilities

Yes

Google Smart Home supported traits

Yes

Samsung SmartThings supported capabilities

Yes

Simplified internal schematics

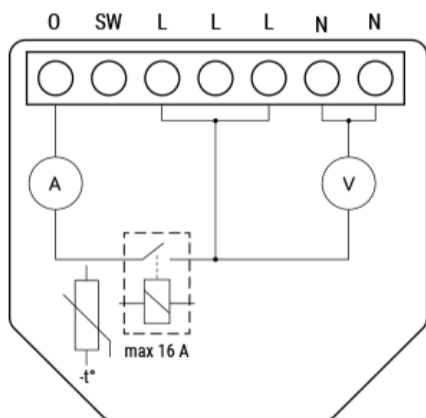

Device electrical interfaces

Inputs

- 1 switch/button input on screw terminal: SW
- 5 power supply inputs on screw terminals: 2 N (+) and 3 L (L)

Outputs

- 1 relay output with power measurement on screw terminal: O

Add-on interface

- Shelly proprietary serial interface

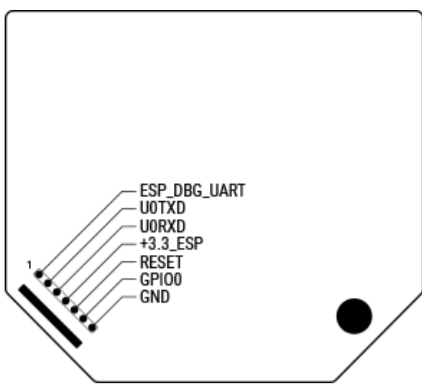

⚠CAUTION! High voltage on the add-on interface when the Device is powered!

Connectivity

- Wi-Fi
- Bluetooth

Safety functions

- Overheating protection
- Overvoltage protection
- Overcurrent protection
- Overpower protection

Supported load types

- Resistive (incandescent bulbs, heating appliances)
- Capacitive (capacitor banks, electronic equipment, motor starting capacitors)
- Inductive with RC Snubber (LED light drivers, transformers, fans, refrigerators, air-conditioners, washing machines, tumble dryers)

User interface

Inputs

- One (Control) button
 - Press and hold for 5 seconds to enable Device access point and Bluetooth connection.
 - Press and hold for 10 seconds to factory reset the Device.

Specifications

Quantity	Value
Physical	
Size (HxWxD):	37x42x16 / 1.46x1.65x0.63
Weight:	27 g / 0.95 oz
Screw terminals max torque:	0.4 Nm / 3.5 lbin
Conductor cross section:	0.5 to 4 mm ² / 20 to 11 AWG (solid, stranded, and bootlace ferrules)
Conductor stripped length:	6 to 7 mm / 0.24 to 0.28 in
Mounting:	Wall console
Shell material:	Plastic

Shell color:	Red
Terminal Color	Black
Environmental	
Ambient working temperature:	-20 °C to 40 °C / -5 °F to 105 °F
Humidity:	30 % to 70 % RH
Max. altitude:	2000 m / 6562 ft
Electrical	
Power supply:	<ul style="list-style-type: none"> • 110-240 V~ • 24-30 V=
Power consumption:	< 1.2 W
External protection:	Cable protection switch in accordance with EN60898-1 (tripping characteristic B or C, max. 16 A rated current, min. 6 kA interrupting rating, energy limiting class 3)
Output circuits ratings	
Max. switching voltage:	<ul style="list-style-type: none"> • 240 V~ • 30 V=
Max. switching current:	<ul style="list-style-type: none"> • 16A (240 V~) • 10A (30 V=)
Sensors, meters	
Internal-temperature sensor:	Yes
Voltmeter (AC):	Yes
Ammeter (AC):	Yes
Radio	
Wi-Fi	
Protocol:	802.11 b/g/n
RF band:	2401 - 2483 MHz
Max. RF power:	< 20 dBm
Range:	Up to 30 m / 100 ft indoors and 50 m / 160 ft outdoors (Depends on local conditions)
Bluetooth	

Protocol:	4.2 with BLE
RF band:	2400 - 2483.5 MHz
Max. RF power:	< 4 dBm
Range:	Up to 10 m / 33 ft indoors and 30 m / 100 ft outdoors (Depends on local conditions)
Microcontroller unit	
CPU:	ESP-Shelly-C38F
Flash:	8MB
Firmware capabilities	
Schedules:	20
Webhooks (URL actions):	20 with 5 URLs per hook
Scripting:	Yes
MQTT:	Yes

Basic wiring diagrams

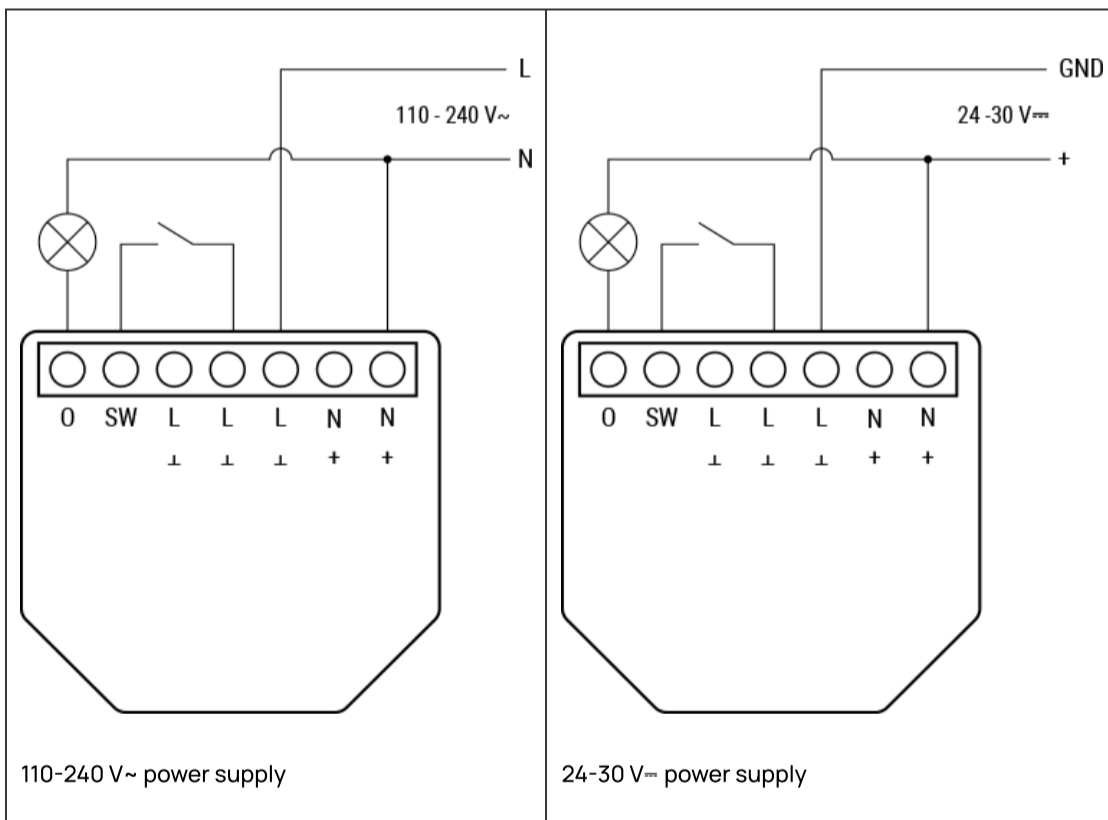

Legend

Terminals		Wires	
O	Load circuit output terminal	L	Live wire (110-240 V~)
SW	Switch (controlling O) input terminal	+	24-30V = positive wire
L	Live terminal (110-240 V~)	N	Neutral wire
N	Neutral terminal	GND	24-30 V = ground wire

+	24-30 V ⁺ positive terminal		
⊖	24-30V ⁻ negative terminal		

Shelly Smart Control

- [Adding the device to the Shelly Smart Control](#)

Components and APIs

- [This device](#)
- [All Shelly devices and services](#)

Compliance

- [Shelly 1PM Gen3 multilingual EU declaration of conformity 266 2026-03-13.pdf](#)
- [Shelly 1PM Gen3 AU NZ Certificate for Suitability.pdf](#)
- [Shelly 1PM Gen3 UK PSTI ACT statement of compliance 266 2026-03-13.pdf](#)
- [Shelly 1PM Gen3 UKCA declaration of conformity 266 2026-03-13.pdf](#)

Compliance archive

[Shelly 1PM Gen3 multilingual EU declaration of conformity 223 2025-12-05.pdf](#)

[Shelly 1PM Gen3 multilingual EU declaration of conformity 132 2025-07-22.pdf](#)





[Shelly 1PM Gen3 multilingual EU declaration of conformity 49 2024-05-29.pdf](#)

[Shelly 1PM Gen3 UK PSTI ACT Statement of compliance 49-1 2024-05-29.pdf](#)

Printed user guide

- [Shelly 1PM Gen3 multilingual printed user and safety guide.pdf](#)
- [Ръководство за употреба и безопасност](#)

Installation guides

<p>Sign up for our newsletter</p> <p>Enter your email address <input type="text"/></p> <p><input type="checkbox"/> „By checking this box, I consent to receive newsletters and marketing information about Shelly products, services and joint campaigns with Shelly's partners via email in accordance with the Privacy policy. I am aware that I can unsubscribe at any time.“</p> <p>     </p>	<p>Company</p> <p>Shelly certified Installers</p> <p>Find a Shelly official Reseller</p> <p>Media center</p> <p>Investors relations</p> <p>Careers</p> <p>Impressum</p>	<p>Help</p> <p>Customer Support</p> <p>Open a support ticket</p> <p>Shelly Community Forum</p> <p>Shelly FB Community</p> <p>FAQs</p> <p>Contact</p>	<p>Learn</p> <p>Shelly X</p> <p>Knowledge base</p> <p>Shelly Compatibility</p> <p>Shelly Academy</p> <p>How to install your Shelly devices</p> <p>Developers API</p>	<p>Information</p> <p>Delivery & Returns</p> <p>General Terms & Conditions</p> <p>Privacy Policy</p> <p>Cookie Policy</p> <p>Sitemap</p> <p>Security Information and Vulnerability Reporting</p> <p>Accessibility</p> <p>EU Data Act</p>
---	--	---	---	---